

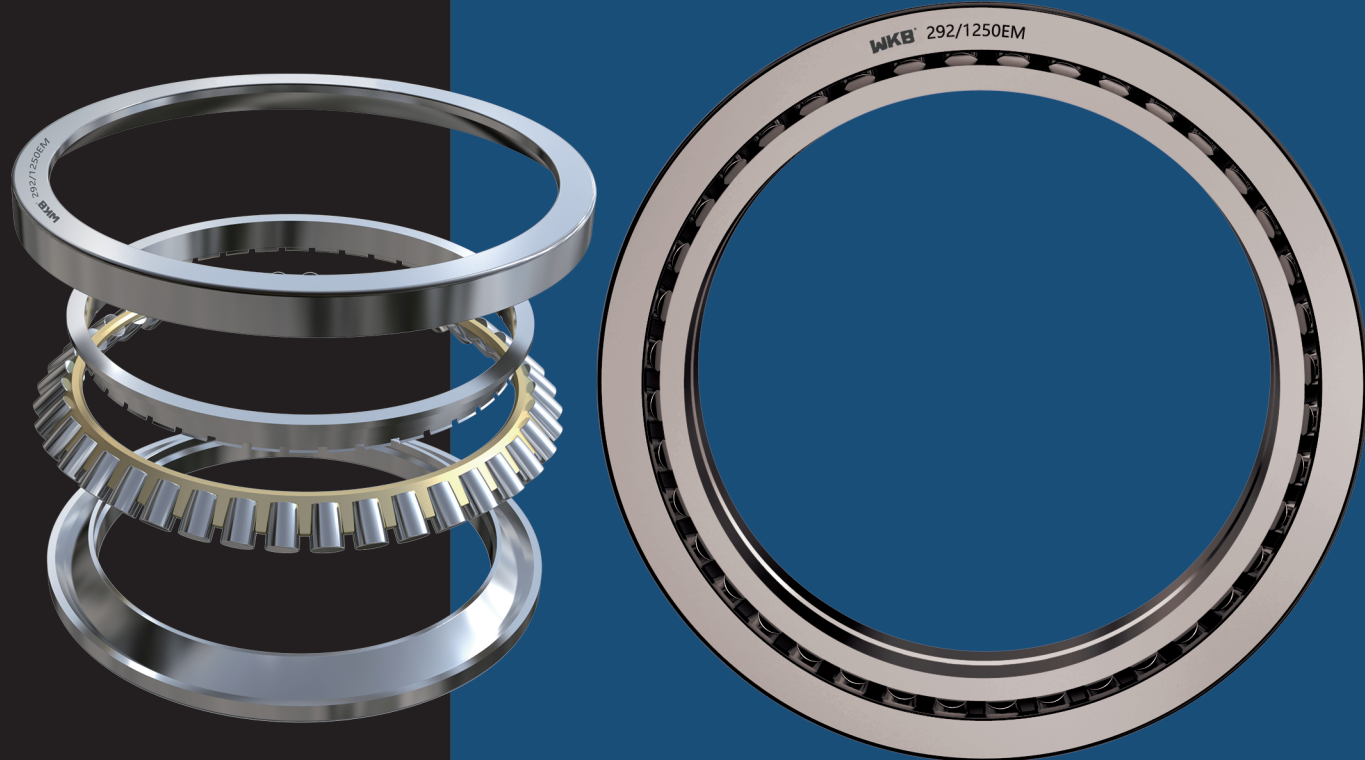

推力调心滚子轴承

Thrust Spherical Roller Bearing



推力调心滚子轴承，滚子为球面型，由于座圈滚道呈球面型结构，因此具有调心性能，该类轴承的轴向负荷能力非常大，在承受轴向负荷的同时还可以承受不超过轴向负荷55%的径向负荷，对同轴度和轴的挠曲变形不甚敏感。该类轴承主要用于水力发电机，立式电机，船用螺旋桨轴，塔吊、塑料注塑挤压机等。

With spherical rollers and races, the thrust self-aligning roller bearing boasts the self-aligning performance. Such bearing has a much larger axial loading capacity and can carrying the radical load no more than 55% of axial load besides the axial load, not so sensitive to the coaxial degree and the shaft deflection or distortion. Such bearing is mainly applied to hydro generator, vertical machine, marine propeller shaft, tower crane, plastic injection extruder and so on.

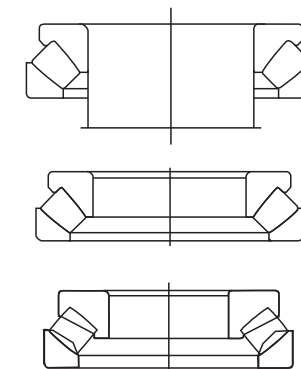

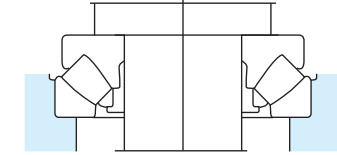
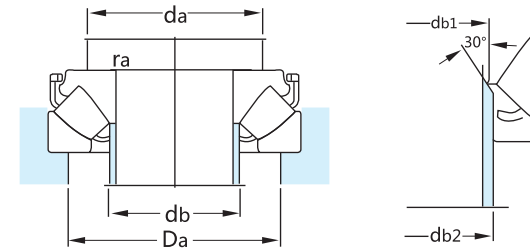
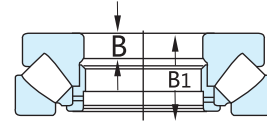
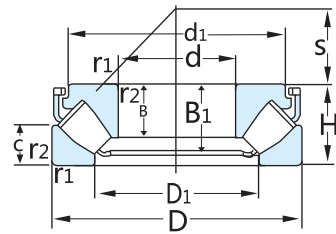

基本尺寸 Basic Size			基本额定负荷 Basic load rating		代号 Code	额定转速 Speed Ratings		质量 Mass
d	D	H	C	C ₀		参考转速 Reference Speed	极限转速 Limiting Speed	
mm			kN		-	r/min		kg
100	170	42	465	1290	29320E 29420E	2200	3600	3.65
	210	67	980	2500		1700	3000	10.5
110	190	48	610	1730	29322E 29422E	1900	3200	5.3
	230	73	1180	3000		1600	2800	13.5
120	210	54	765	2120	29324E 29424E	1700	2800	7.35
	250	78	1370	3450		1500	2600	17.5
130	225	58	865	2500	29326E 29426E	1600	2600	9
	270	85	1560	4050		1300	2400	22
140	240	60	980	2850	29328E 29428E	1500	2600	10.5
	280	85	1630	4300		1300	2400	23
150	215	39	408	1600	29230E 29330E 29430E	1800	2800	4.3
	250	60	1000	2850		1500	2400	11
	300	90	1860	5100		1200	2200	28
160	225	39	357	1460	29232E 29332E 29432E		1700	4.8
	270	67	1180	3450		1300	2200	14.5
	320	95	2080	5600		1100	2000	32
170	240	42	408	1660	29234E 29334E 29434E		1600	5.95
	280	67	1200	3550		1300	2200	15
	340	103	2360	6550		1100	1900	44.5
180	250	42	495	2040	29236E 29336E 29436E	1600	2600	5.8
	300	73	1430	4300		1200	2000	19.5
	360	109	2600	7350		1000	1800	52.5
190	270	48	518	2200	29238EM 29338E 29438E		1400	8.7
	320	78	1630	4750		1100	1900	23.5
	380	115	2850	8000		950	1700	60.5
200	280	48	656	2650	29240E 29340E 29440E	1400	2200	9.3
	340	85	1860	5500		1000	1700	29.5
	400	122	3200	9000		850	1600	72
220	300	48	690	3000	29244E 29344E 29444E	1300	2200	10
	360	85	2000	6300		1000	1700	33.5
	420	122	3350	9650		850	1500	75

尺寸 Dimensions								挡肩及倒角尺寸 Shoulder and chamfer dimensions				
d	d ₁	D ₁	B	B ₁	C	r _{1,2} min	S	d _a min	d _{b1} max	d _{b2} max	D _a max	r _a max
mm								mm				
100	152	128	26.2	36.3	20.5	1.5	58	130	107	107	147	1.5
	182	142	43	57.3	32	3	62	150	110	110	175	2.5
110	171	140	30.3	41.7	24.8	2	63.8	145	117	117	164	2
	199	156	47	64.7	34.7	3	69	165	120	129	193	2.5
120	188	155	34	48.2	27	2.1	70	160	128	128	181	2
	216	171	50.5	70.3	36.5	4	74	180	132	142	209	3
130	203	166	36.7	50.6	30.1	2.1	75.6	175	138	143	194	2
	234	185	54	76	40.9	4	81	195	142	153	227	3
140	216	177	38.5	54	30	2.1	82	185	148	154	208	2
	245	195	54	75.6	41	4	86	205	153	162	236	3
150	200	176	24	34.3	20.5	1.5	82	180	154	154	193	1.5
	223	190	38	54.9	28	2.1	87	195	158	163	219	2
	262	208	58	80.8	43.4	4	92	220	163	175	253	3
160	220	188	11	34.3	20	1.5	87	190			204	1.5
	243	203	42	60	33	3	92	210	169	176	235	2.5
	279	224	60.5	84.3	45.5	5	99	235	175	189	270	4
170	235	201	13	40	22	1.5	93	205			218	1.5
	251	215	42.2	61.1	30.5	3	96	220	178	188	245	2.5
	297	236	65.5	91.2	50	5	104	250	185	199	286	4
180	234	208	26	36.9	22	1.5	97	210	187	187	226	1.5
	270	227	46	66.2	35.5	3	103	235	189	195	262	2.5
	315	250	69.5	96.4	53	5	110	265	196	210	304	4
190	255	226	14	45	25.5	2	103	225			243	2
	285	244	49	71.3	36	4	110	250	200	211	280	3
	332	265	73	101	55.5	5	117	280	207	223	321	4
200	260	233	30	43.4	24	2	108	235	206	207	253	2
	304	257	53.5	76.7	40	4	116	265	211	224	297	3
	350	278	77	107.1	59.4	5	122	295	217	234	337	4
220	280	252	30	43.4	24.5	2	117	255	224.5	227	271	2
	326	274	55	77.7	41	4	125	285	229	240	316	3
	371	300	77	107.4	58.5	6	132	315	238	254	358	5

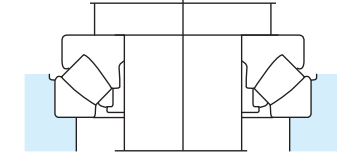
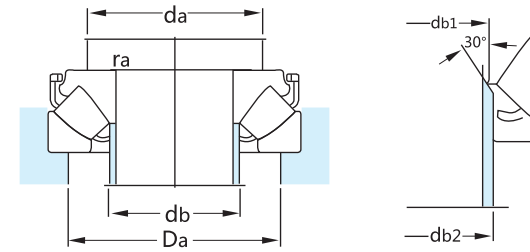
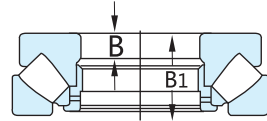
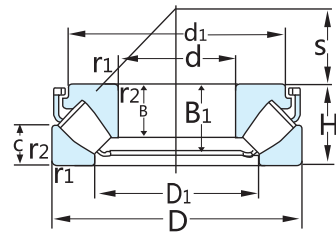

基本尺寸 Basic Size			基本额定负荷 Basic load rating		代号 Code	额定转速 Speed Ratings		质量 Mass	
d	D	H	动态dynamic C	静态static C ₀		参考转速 Reference Speed	极限转速 Limiting Speed		
mm			kN		-	r/min		kg	
240	340	60	799	3450	29248 29348E 29448E	1100	1800	16.5	
	380	85	2040	6550		1000	1600		35.5
	440	122	3400	10200		850	1500		80
260	360	60	817	3650	29252 29352E 29452E	1100	1700	18.5	
	420	95	2550	8300		850	1400		49
	480	132	4050	12900		750	1300		105
280	380	60	863	4000	29256 29356E 29456E	1000	1700	19.5	
	440	95	2550	8650		850	1400		53
	520	145	4900	15300		670	1200		135
300	420	73	1070	4800	29260 29360E 29460E	900	1400	30.5	
	480	109	3100	10600		750	1200		75
	540	145	5000	16600		670	1200		140
320	440	73	1110	5100	29264 29364E 29464E	850	1400	33	
	500	109	3350	11200		750	1200		78
	580	155	5700	19000		600	1100		175
340	460	73	1130	5400	29268 29368 29468E	850	1300	33.5	
	540	122	2710	11000		600	1100		105
	620	170	6700	22400		560	1000		220
360	500	85	1460	6800	29272 29372 29472EM	750	1200	52	
	560	122	2760	11600		600	1100		110
	640	170	6200	21200		560	950		230
380	520	85	1580	7650	29276 29376 29476EM	700	1100	53	
	600	132	3340	14000		530	1000		140
	670	175	6800	24000		530	900		260
400	540	85	1610	8000	29280 29380 29480EM	700	1100	55.5	
	620	132	3450	14600		530	950		150
	710	185	7650	26500		480	850		310
420	580	95	1990	9800	29284 29384 29484EM	630	1000	75.5	
	650	140	3740	16000		500	900		170
	730	185	7800	27500		480	850		325

尺寸 Dimensions								挡肩及倒角尺寸 Shoulder and chamfer dimensions				
d	d ₁	D ₁	B	B ₁	C	r _{1,2} min	S	d _a min	d _{b1} max	d _{b2} max	D _a max	r _a max
mm								mm				
240	330	283	19	57	30	2.1	130	290			308	2
	345	296	54	77.8	40.5	4	135	305	249	259	336	3
	391	322	76	107.1	59	6	142	335	258	276	378	5
260	350	302	19	57	30	2.1	139	310			326	2
	382	324	61	86.6	46	5	148	335	273	286	370	4
	427	346	86	119	63	6	154	365	278	296	412	5
280	370	323	19	57	30	2.1	150	325			347	2
	401	343	62	86.7	45.5	5	158	355	293	305	390	4
	464	372	95	129.9	70	6	166	395	300	320	446	5
300	405	353	21	69	38	3	162	360			380	2.5
	434	372	70	98.9	51	5	168	385	313	329	423	4
	485	392	95	130.3	70.5	6	175	415	319	340	465	5
320	430	372	21	69	38	3	172	380			400	2.5
	454	391	68	97.8	53	5	180	405	332	347	442	4
	520	422	102	139.4	74.5	7.5	191	450	344	367	500	6
340	445	395	21	69	37.5	3	183	400			422	2.5
	520	428	40.6	117	59.5	5	192	440			479	4
	557	445	112	151.4	84	7.5	201	475	363	386	530	6
360	485	423	25	81	44	4	195	430			453	3
	540	448	40.5	117	59.5	5	202	460			500	4
	580	474	63	164	83.5	7.5	210	495			550	6
380	505	441	27	81	42	4	202	450			473	3
	580	477	45	127	63.5	6	216	495			535	5
	610	494	67	168	87.5	7.5	222	525			580	6
400	526	460	27	81	42.2	4	212	470			493	3
	596	494	43	127	64	6	225	510			550	5
	645	525	69	178	89.5	7.5	234	550			615	6
420	564	489	30	91	46	4	225	500			525	4
	626	520	49	135	67.5	6	235	535			580	5
	665	545	70	178	90.5	7.5	244	575			635	6

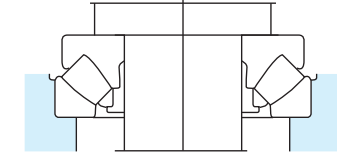
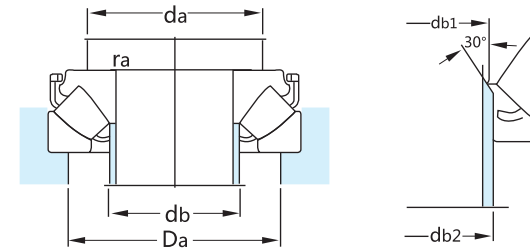
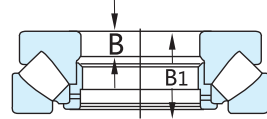
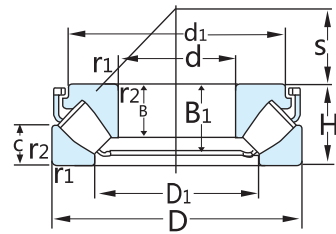

基本尺寸 Basic Size			基本额定负荷 Basic load rating		代号 Code	额定转速 Speed Ratings		质量 Mass
d	D	H	C	C ₀		参考转速 Reference Speed	极限转速 Limiting Speed	
mm			kN		-	r/min		kg
440	600	95	2070	10400	29288	630	1000	78
	680	145	5200	19300	29388EM	530	850	180
	780	206	9000	32000	29488EM	430	750	410
460	620	95	2070	10600	29292	600	950	81
	710	150	4310	19000	29392	450	800	215
	800	206	9300	33500	29492EM	430	750	425
480	650	103	2350	11800	29296	560	900	98
	730	150	4370	19600	29396	450	800	220
	850	224	9550	39000	29496EM	340	670	550
500	670	103	2390	12500	292/500	560	900	100
	750	150	4490	20400	293/500	430	800	235
	870	224	9370	40000	294/500EM	340	670	560
530	710	109	3110	15300	292/530EM	530	850	115
	800	160	5870	26500	293/530EM	400	750	270
	920	236	10500	44000	294/530EM	320	630	650
560	750	115	2990	16000	292/560	480	800	140
	850	175	6900	31000	293/560EM	360	600	360
	980	250	12000	51000	294/560EM	300	560	810
600	800	122	3740	18600	292/600EM	450	700	170
	900	180	7530	34500	293/600	340	500	405
	1030	258	13100	56000	294/600EM	280	530	845
630	850	132	4770	23600	292/630EM	400	670	210
	950	190	8450	38000	293/630EM	320	600	485
	1090	280	14400	62000	294/630EM	260	500	1040
670	900	140	4200	22800	292/670	380		255
	1000	200	8970	41500	293/670EM	300		545
	1150	290	15400	68000	294/670EM	240	450	1210
710	950	145	5230	27000	292/710EM	360		290
	1060	212	9950	45500	293/710EM	280	500	610
	1220	308	17600	76500	294/710EF	220	430	1500

尺寸 Dimensions								挡肩及倒角尺寸 Shoulder and chamfer dimensions		
d	d ₁	D ₁	B	B ₁	C	r _{1,2} min	S	d _a min	D _a max	r _a max
mm								mm		
440	585	508	30	91	46.5	5	235	520	545	4
	626	540	49	140	70.5	6	249	560	605	5
	710	577	77	199	101	9.5	257	605	675	8
460	605	530	30	91	46	5	245	540	565	4
	685	567	50	144	72.5	6	257	585	630	5
	730	596	77	199	101.5	9.5	268	630	695	8
480	635	556	33	99	53.5	5	259	570	595	4
	705	591	51	144	73.5	6	270	610	655	5
	770	625	88	216	108	9.5	280	660	735	8
500	654	574	33	99	53.5	5	268	585	615	4
	725	611	50	144	74	6	280	630	675	5
	795	648	86	216	110	9.5	290	685	755	8
530	675	608	32	105	56	5	285	620	655	4
	741	641	55	154	81	7.5	295	665	715	6
	840	686	89	228	116	9.5	308	725	800	8
560	732	644	37	111	61	5	302	655	685	4
	790	677	63	169	86	7.5	320	710	765	6
	890	727	99	241	122	12	328	770	850	10
600	760	688	39	117	60	5	321	700	735	4
	840	720	65	174	89	7.5	340	755	810	6
	940	769	99	249	128	12	349	815	900	10
630	810	723	50	127	62	6	338	740	780	5
	880	761	68	188	92	9.5	359	795	860	8
	995	815	107	270	137	12	365	860	950	10
670	880	773	45	135	73	6	361	790	825	5
	935	804	73	193	98	9.5	379	840	900	8
	1045	864	110	280	141	15	387	905	1000	12
710	900	815	46	140	71	6	380	830	875	5
	985	855	74	205	103	9.5	404	890	960	8
	1110	917	117	298	149	15	415	965	1070	12

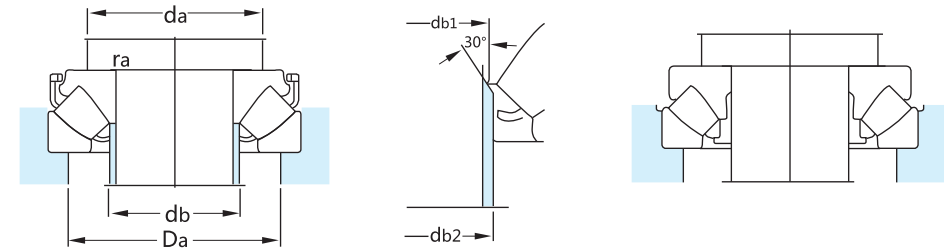
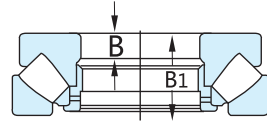
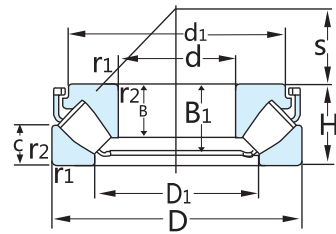

基本尺寸 Basic Size			基本额定负荷 Basic load rating 动态dynamic 静态static		代号 Code	额定转速 Speed Ratings 参考转速 极限转速 Reference Speed Limiting Speed		质量 Mass
d	D	H	C	C ₀	-	Speed	Speed	kg
mm			kN			r/min		
750	1000	150	6100	31000	292/750EM			325
	1120	224	9370	45000	293/750			770
	1280	315	18700	85000	294/750EF	200	400	1650
800	1060	155	6560	34500	292/800EM	320	530	380
	1180	230	11300	55000	293/800EM	240	450	810
	1360	335	20200	93000	294/800EF	190	360	2030
850	1120	160	6730	36000	292/850EM			425
	1440	354	23900	108000	294/850EF	170	340	2390
900	1520	372	26700	122000	294/900EF	160	300	2650
950	1250	180	8280	45500	292/950EM			600
	1600	390	28200	132000	294/950EF	140	280	3070
1000	1670	402	31100	140000	294/1000EF	130	260	3390
1060	1400	206	10500	58500	292/1060EF			860
	1770	426	33400	156000	294/1060EF	120	240	4280
1180	1520	206	10900	64000	292/1180EF			950
1250	1800	330	24800	129000	293/1250EF			2770
1600	2280	408	36800	200000	293/1600EF			5375

尺寸 Dimensions								挡肩及倒角尺寸 Shoulder and chamfer dimensions		
d	d ₁	D ₁	B	B ₁	C	r _{1,2} min	S	d _a min	D _a max	r _a max
mm								mm		
750	950	858	50	144	74	6	409	880	925	5
	1086	910	76	216	109	9.5	415	935	1000	8
	1170	964	121	305	153	15	436	1015	1120	12
800	1010	911	52	149	77	7.5	434	935	980	6
	1099	958	78	222	117	9.5	440	995	1060	8
	1250	1034	123	324	165	15	462	1080	1185	12
850	1060	967	47	154	82	7.5	455	980	1030	6
	1315	1077	142	342	172	15	507	1160	1270	12
900	1394	1137	147	360	186	15	518	1215	1320	12
950	1185	1081	58	174	88	7.5	507	1095	1155	6
	1470	1209	153	377	191	15	546	1275	1400	12
1000	1531	1270	154.9	389	190	15	599	1350	1490	12
1060	1325	1211	66	199	100	9.5	566	1225	1290	8
	1615	1349	192	412	207	15	610	1410	1555	12
1180	1450	1331	83	199	101	9.5	625	1345	1410	8
1250	1685	1474	147	319	161	12	698	1540	1640	10
1600	2130	1885	166	395	195	19	894	1955	2090	15